

料号审核:

变更说明	序号	变更描述	原因	设计	日期
0		新版本发行	-	黄海祥	2020.10.16
1		-	-	-	-
2		-	-	-	-

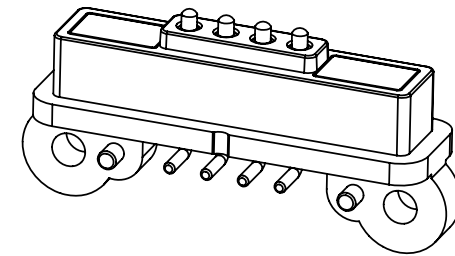
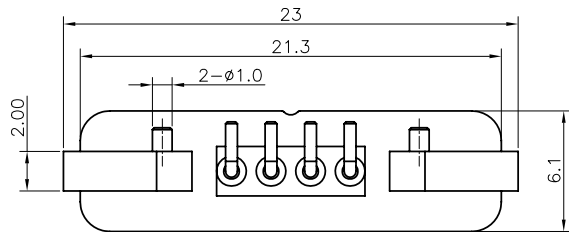
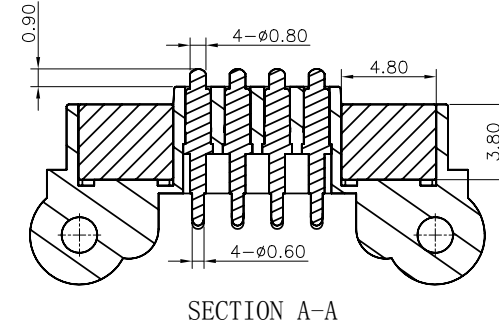
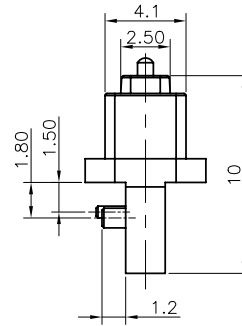
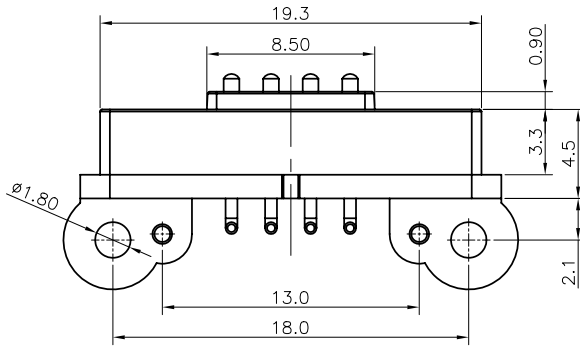
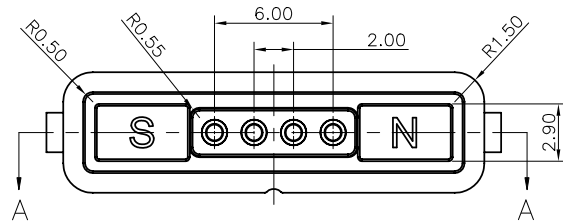

3D VIEW

NOTES:

1.MATERIALS:

HOUSING: PA9T COLOR:BLACK.
 POGO PIN: C3604.
 MAGNET: N52.

2.PLATING:

POGO PIN: Au 5u" Min. OVER 50~120u" NICKEL.
 MAGNET: NICKEL PLATING.

3.ELECTRICAL:

RATED CURRENT: 2A.
 RATED VOLTAGE: 5V.
 INSULATION RESISTANCE: 100MΩ Min.
 DIELECTRIC WITHSTANDING VOLTAGE: 100V AT 60Hz.
 CONTACT RESISTANCE: 30mΩ Max. BEFORE TEST AND 60mΩ Max. AFTER TEST POGO PIN WORKING STROKE.

7	-	-	-	-	-	-
6	-	-	-	-	-	-
5	-	-	-	-	-	-
4	-	-	-	-	-	-
3	-	方形磁铁	方形磁铁4.8*2.9*3.8mm N52 表面镀镍 盐雾48H	2	PCS	-
2	-	插针	尺寸Ø1.5*10.1mm 材质C3604 针头镀金5u" 针管镀金3u" 盐雾48H	4	PCS	-
1	-	TK4PIN公座支架	尺寸23.0*6.1*10.0mm 材质PA9T黑色 PH=2.0	1	PCS	-
序号	料号	物料名称	描述	用量	单位	

POMAGTOR
磁性连接—专业为您定制

深圳市泰科汉泽精密电子有限公司
Pomagtor Precision Electronics

描述	TK-4PIN公座磁吸连接器 PH=2.0 PA9T黑色 折弯款			版本	A0	比例	1:1	单位	mm
料号	-			绘图/日期	黄海祥	2020.10.16	审核/日期	-	-
未标注公差	x.±0.20	.x±0.15	.xx±0.10	x'.±2'	.x'±0.5'				

料号审核:

变更说明	序号	变更描述	原因	设计	日期
0		新版本发行	-	黄海祥	2020.10.16
1		-	-	-	-
2		-	-	-	-

NOTES:

1.MATERIALS:

HOUSING: PA9T COLOR:BLACK.
POWER PIN: C3604.
MAGNET: N52.

2.PLATING:

POWER PIN: Au 5u" Min. OVER 50~120u" NICKEL.
MAGNET: NICKEL PLATING.

3.ELECTRICAL:

RATED CURRENT: 2A.
RATED VOLTAGE: 5V.
INSULATION RESISTANCE: 100MΩ Min.
DIELECTRIC WITHSTANDING VOLTAGE: 100V AT 60Hz.
CONTACT RESISTANCE: 30mΩ Max. BEFORE TEST AND 60mΩ Max. AFTER TEST POGO PIN WORKING STROKE.

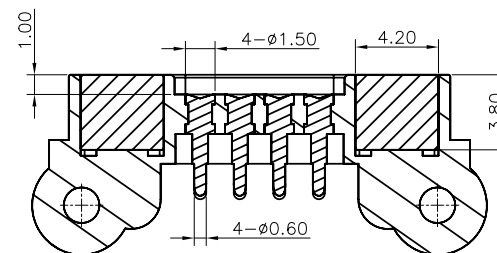
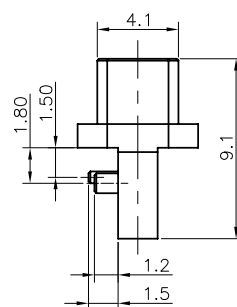
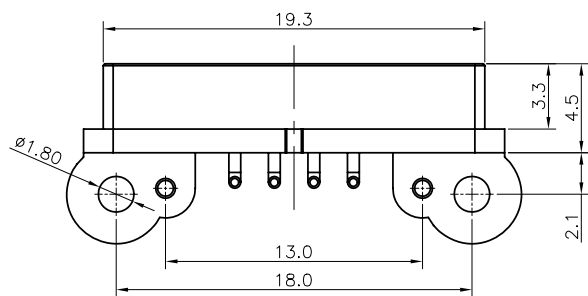
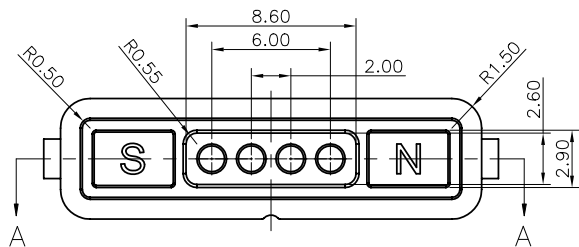

SECTION A-A

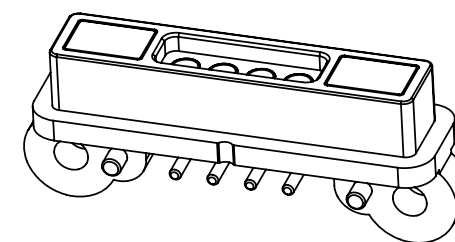
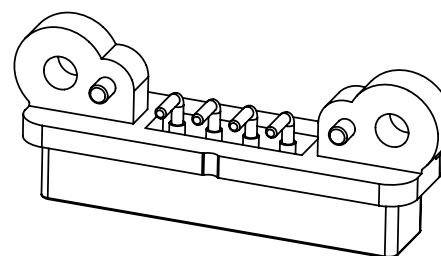
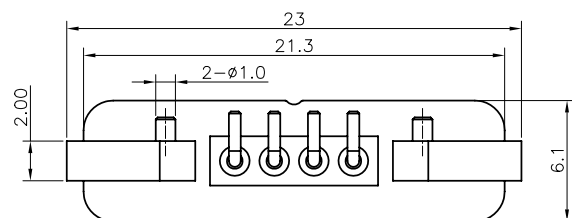

3D VIEW

序号	料号	物料名称	描述	用量	单位
7	-	-	-	-	-
6	-	-	-	-	-
5	-	-	-	-	-
4	-	-	-	-	-
3	-	方形磁铁	方形磁铁4.2*2.9*3.8mm N52 表面镀镍 盐雾48H	2	PCS
2	-	插针	尺寸ø1.5*7.3mm 材质C3604 镀金5u" 盐雾48H	4	PCS
1	-	TK4PIN母座支架	尺寸23.0*6.1*9.1mm 材质PA9T黑色 PH=2.0	1	PCS

POMAGTOR
磁性连接—专业为您定制

深圳市泰科汉泽精密电子有限公司
Pomagtor Precision Electronics

描述	TK-4PIN母座磁吸连接器 PH=2.0 PA9T黑色 折弯款	版本	A0	比例	1:1	单位	mm
料号	-	绘图/日期	黄海祥	2020.10.16	审核/日期	-	-
	未标注公差	x.±0.20	.x±0.15	.xx±0.10	审核/日期	-	-
		x'.±2'	.x'±0.5'				