

PVC圆线(φ3.0)四芯

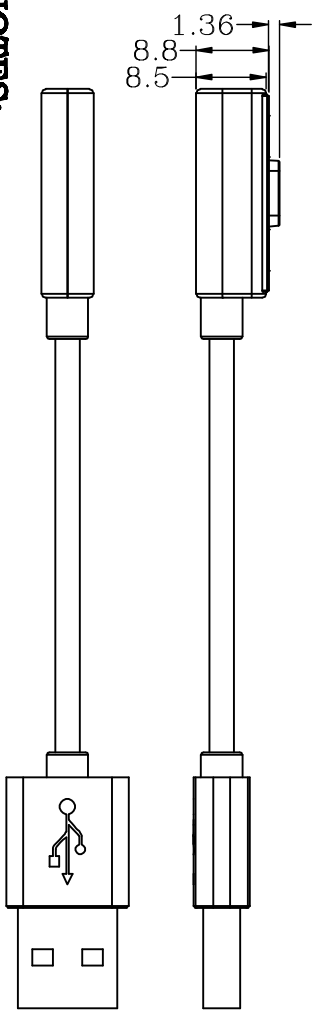

NOTES:

- 1.0 PLATING:**
- 1) Contact plating: brass Au5u"over 50-80u" Ni
 - 2) Contact solder area plating: brass Au 5u" over 50-80u" Ni
 - 3) Spring: SUS
 - 4) Housing: PA46 black
 - 5) Magnet: N52
 - 6) Cable: PVC, OD3.0
- 2.0 Rated voltage(Per Contact): 12 Volts**
- 3.0 Rated Current(Per Contact): 2A maximum**
- 4.0 Recommended Working Stroke&Force:**
- 1) Stroke 0.8mm(Per Contact): 60gfMax
- 5.0 Mechanical life:**
- 1) 0.8mm(Mechanical life): 10,000 Cycles Min
 - 2) 6.0 Working Temperature Range: -30~85°

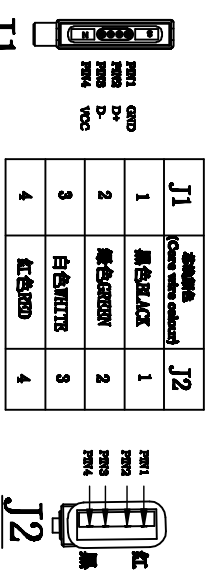
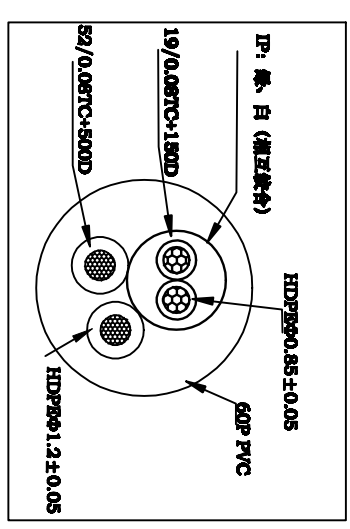
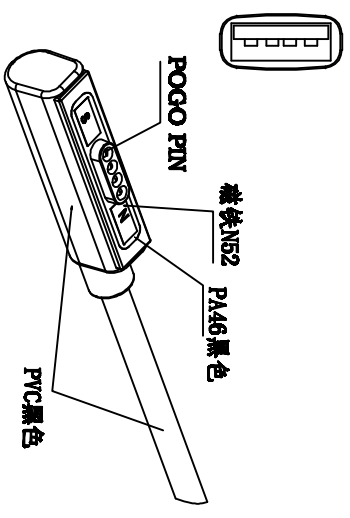

J1	磁接触 (Core with solder)	J2
1	黑色或LACK	1
2	绿色GREEN	2
3	白色WHITE	3
4	红色RED	4

由 Autodesk 教育版产品制作

<p>模具编号 HZ-00029</p> <p>模具编号 HY80-00273-003-A</p>		<p>设计者 HY80-00273-002-A</p>		<p>描述 ZHL C-4PIN 磁环线 黑色, 1m</p>		<p>图号 WPS2017111701A</p>		<p>单位 mm</p>		<p>版本 A1</p>	
<p>变更记录</p>		<p>原因</p>		<p>日期</p>		<p>料号 HY91-00180-001</p>		<p>公差 未标注尺寸公差 +/- 0.15</p>		<p>比例 1:1</p>	
<p>1</p>		<p>2</p>		<p>3</p>		<p>图号/日期 2017.11.17</p>		<p>审核/日期 2017.11.17</p>		<p>2017.11.17</p>	

深圳市泰科汉洋精密电子有限公司
Pomagtor Precision Electronics

POMAGTOR
磁性连接—專業為您定制

1 2 3 4 5 6

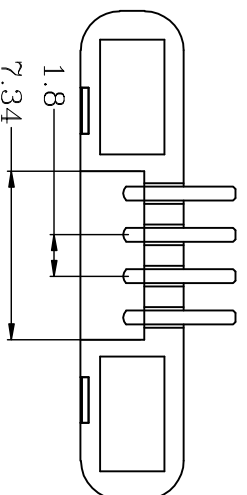
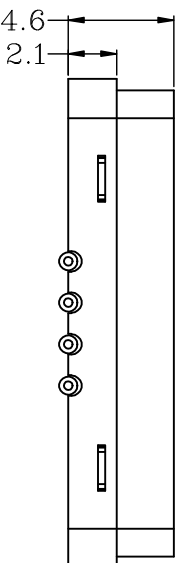
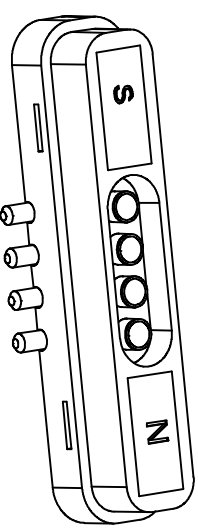
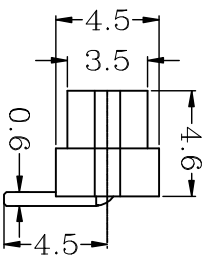
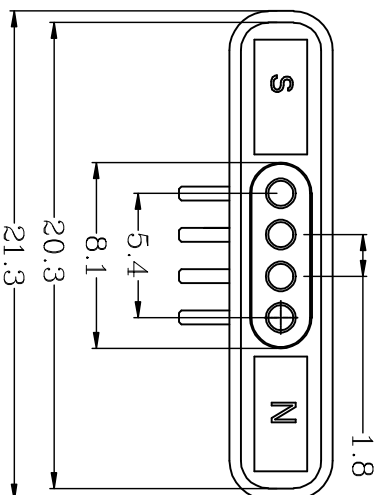

- NOTES:**
1.0 PLATING:
 1) Contact plating: brass Au 5u" over 50-80u" Ni
 2) Contact solder area plating: brass Au 5u" over 50-80u" Ni
 3) Housing: PA46 black
 4) Magnet: N52
2.0 Rated voltage(Per Contact): 12 Volts
3.0 Rated Current(Per Contact): 2A maximum
4.0 Working Temperature Range: -30~85°

由 Autodesk 教育版产品制作

由 Autodesk 教育版产品制作

模具编号		模具编号		描述		POMMAGTOR 磁性连接—專案需您定制		深圳市泰科汉洋精密电子有限公司 Pomagtor Precision Electronics	
变更描述		原因		料号		ZHLC-4PIN 母座			
1				HY91-00180-002	图号	WPS2017111701A	单位	mm	版本
2					公差	+/-0.15	绘图/日期	王日胜	比例
3					未标注公差	+/-0.2°	审核/日期	王日胜	2017.11.17
变更记录				料号		公差		2017.11.17	