

NOTES:  
 1.0 PLATING:  
 1)Contact plating:brass Au5u"over 50-80u" Ni  
 2)Spring: SUS  
 3)Housing: TPE white  
 4)Magnet: N52  
 5)Cable: TPE, DD3.5  
 6)PCB: FR4

2.0 Rated voltage(Per Contact): 5 Volts  
 3.0 Rated Current(Per Contact): 3A maximum  
 4.0 Recommended Working Stroke&Force:  
 1)Stroke 0.8mm(Per Contact); 60gfMax  
 5.0 Mechanical life:  
 1)0.8mm(Mechanical life): 10,000 Cycles Min  
 6.0 Working Temperature Range: -30~85°

**POMMAGTOR**  
 磁性连接—專業為您定制

深圳市泰科汉泽精密电子有限公司  
**Pomagtor Precision Electronics**

模具编号  
 设计者  
 日期

序号	变更描述	原因	设计者	日期	描述	料号	图档编号	类型/日期	单位	版本
1	---	---	---	---	10mm-2PIN-圆形水杯-侧出一公差	---	---	---	mm	A1
2	---	---	---	---	未标注尺寸公差 +/-0.15	---	---	类型/日期	王耀辉	2017.12.01
3	---	---	---	---	未标注角度公差 +/-2°	---	---	审核/日期	---	---

变更记录表

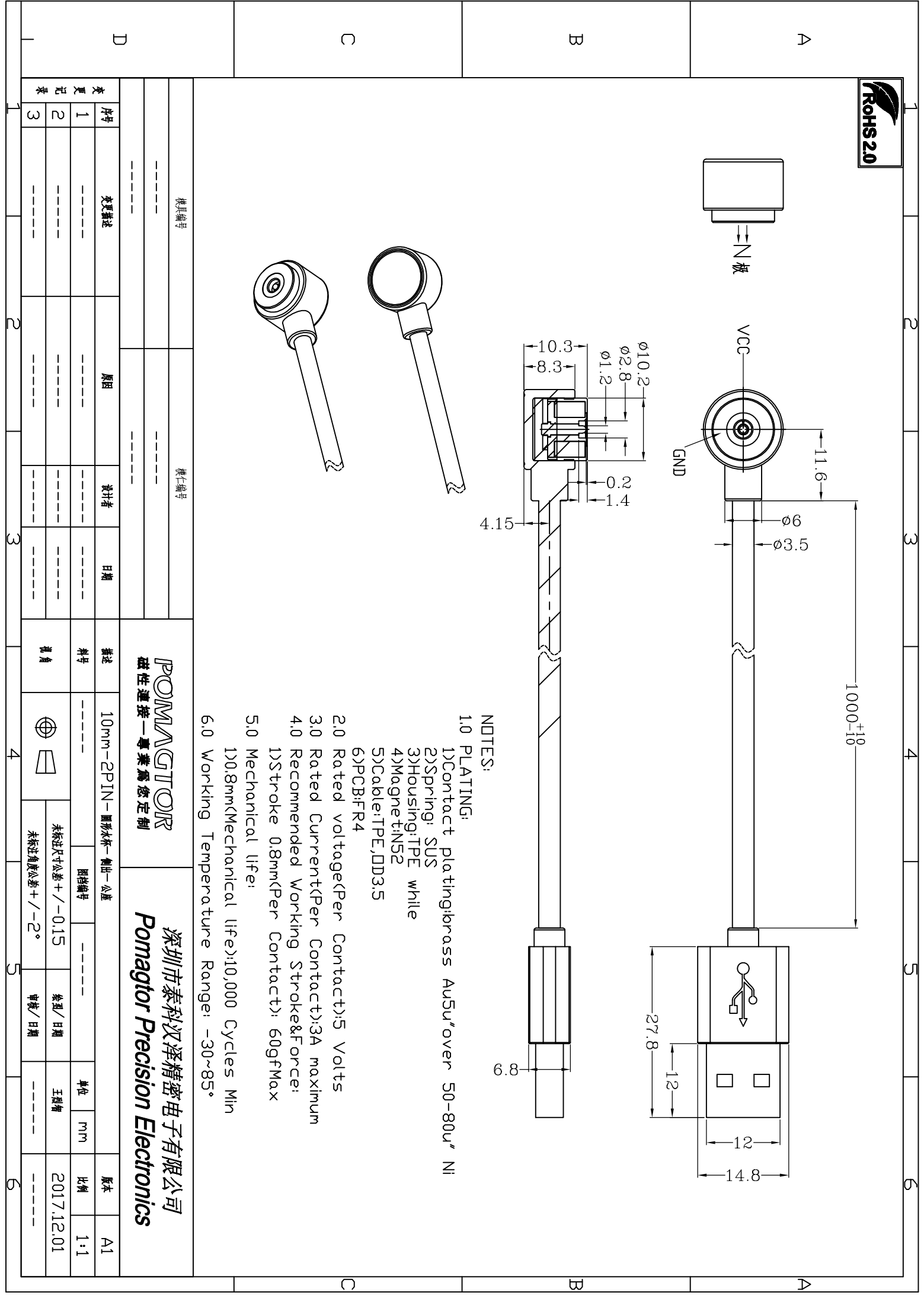

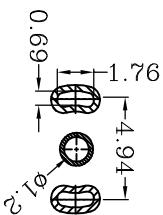
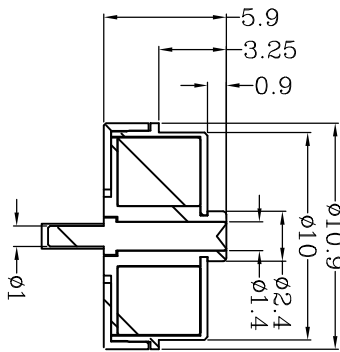
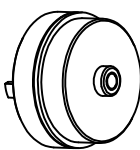
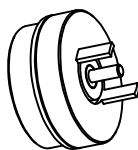
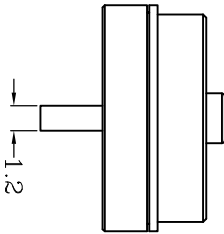
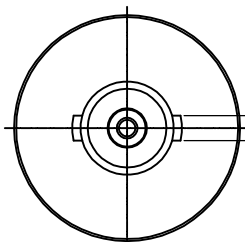
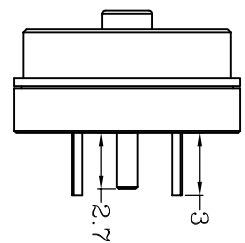
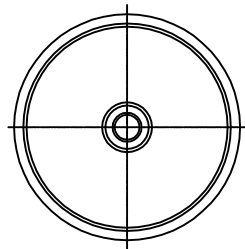

- NOTES:
- 1.0 PLATING:
- 1) Contact plating: brass Au5u" over 50-80u" Ni  
 2) Contact solder area plating: brassAu 5u" over 50-80u" Ni  
 3) Housing: LCP while  
 4) Magnet: NiS2  
 2.0 Rated voltage (Per Contact): 5 Volts  
 3.0 Rated Current (Per Contact): 3A maximum  
 4.0 Working Temperature Range: -30~85°

PCB LAYOUT  
 Layout Tolerance: ±0.05mm

模具编号

模仁编号

序号	变更描述	原因	设计者	日期	描述	10mm-2PIN-圆形水杯-母座	限制编号	类型/日期	单位	版本
1	-----	-----	-----	-----	料号	-----	-----	类型/日期	mm	A1
2	-----	-----	-----	-----	视角	-----	-----	类型/日期	-----	1:1
3	-----	-----	-----	-----	-----	-----	-----	审核/日期	-----	-----

**POMMAGTOR**  
 磁性连接—专业为您定制

深圳市泰科汉泽精密电子有限公司  
**Pomagtor Precision Electronics**

变更记录表

1 2 3 4 5 6