

REV	ECN NO.	DETAILS	BY	DATE
1	A0	new version release	LZH	2022/08/10
2	A1	铜壳与插针镀层更新为镀钯金3u” 增加选型表, 其他不变	LZH	2022/10/11
3				

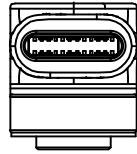

NOTES:

- 1.0 Rated voltage: 5 Volts
- 2.0 Rated Current: 3 A maximum
- 3.0 Contact Resistance: 50mΩ maximum
- 4.0 Salt Spray: 48H Min
- 5.0 Working Temperature Range: -40~85°C
- 6.0 Marked with "*" as key dimension
- 7.0 The product must conform to the latest RoHS CP65

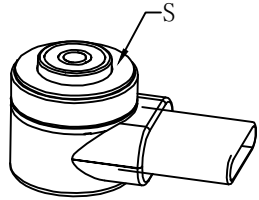
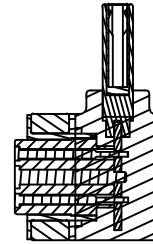
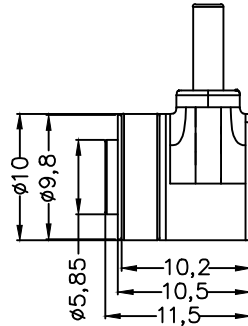
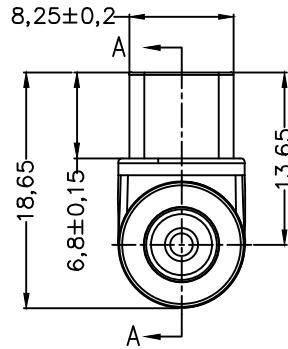
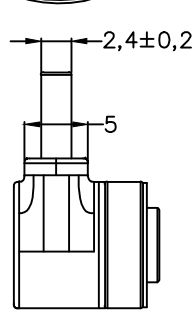

SECTION A-A

A1	A2	A3	A4	A5	A6	A7	A8	A9	A10	A11	A12
GND	TX1+	TX1-	VCC	CC1	D+	D-	SUB1	VCC	RX2-	RX2+	GND
B12	B11	B10	B9	B8	B7	B6	B5	B4	B3	B2	B1
GND	RX1+	RX1-	VCC	SUB2	D-	D+	NC	VCC	TX2-	TX2+	GND

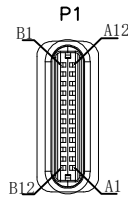

Connection method

	P1	P2
A5	CC1	1
A4, B9, A9, B4	VCC	2
A1, B12, A12, B1	GND	3

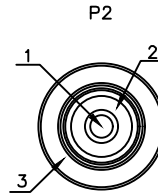

Material code	Product color
RD90.LZH0220704-001	White
RD90.LZH0220816-002	Black
RD90.LZH0220816-003	light grey

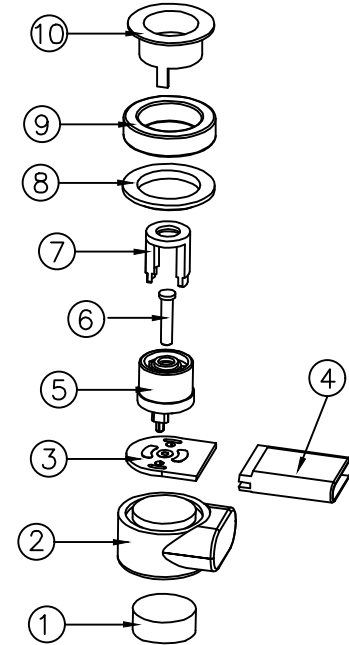

10	electrode ring	H59	Ni1.5~3.0um+Pd 0.075um	1pcs	-
9	Magnet	N52	Nickel plated after 48 hours of salt spray	1pcs	-
8	Press ring	H59	Nickel plated after 48 hours of salt spray	1pcs	-
7	electrode ring	H59	Ni1.5~3.0um+Pd 0.075um	1pcs	-
6	pin	HBI59-1.5	Ni1.5~3.0um+Pd 0.075um	1pcs	-
5	Housing	PA9T White	Fire rating: UL94V-0	1pcs	-
4	TYPE-C plug	-	-	1pcs	-
3	PCB	FR-4	-	1pcs	-
2	External Molding Plastic	TPE 90A White	Fire rating: UL94V-0	1pcs	-
1	Internal Molding Plastic	PE Raw Material Color: Transparent	-	1pcs	-
Item	Part Name	Material	Finish	Q'TY	Remarks

*UNLESS OTHERWISE STATED
ALL DIMENSIONS ARE IN
MILLIMETRES
LINEAR TOLERANCE:
X:±0.20 .X±0.15 .XX±0.10
X*:±2* .X*±0.5**
Pomagtor
Website:www.pomagtor.net

POMAGTOR
PROFESSIONAL CUSTOMIZATION SINCE 2007
HIGH FREQUENCY POGO PIN MAGNETIC CONNECTOR

ITEM	Magnetic connector	REV	A0	DRAWN BY	CHECKED BY	APPROVED BY
S/N.	-	SCALE	1	LZH		
RD.S/N.	RD90.LZH0220704-001	UNIT	mm			
VEIW ANGLE		DATE	2022/10/11			
		SHEET	1 of 1			

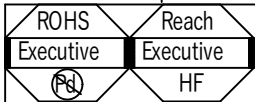

REV	ECN NO.	DETAILS	BY	DATE
1	A0	new version release	LZH	2022/08/10
2	A1	Modify plug length	ZQ	2022/10/09
3	A2	产品颜色更新为灰色, 针头更新为镀钨金3u" 针管镀钨金1u" 增加磁吸力要求	LZH	2022/10/11

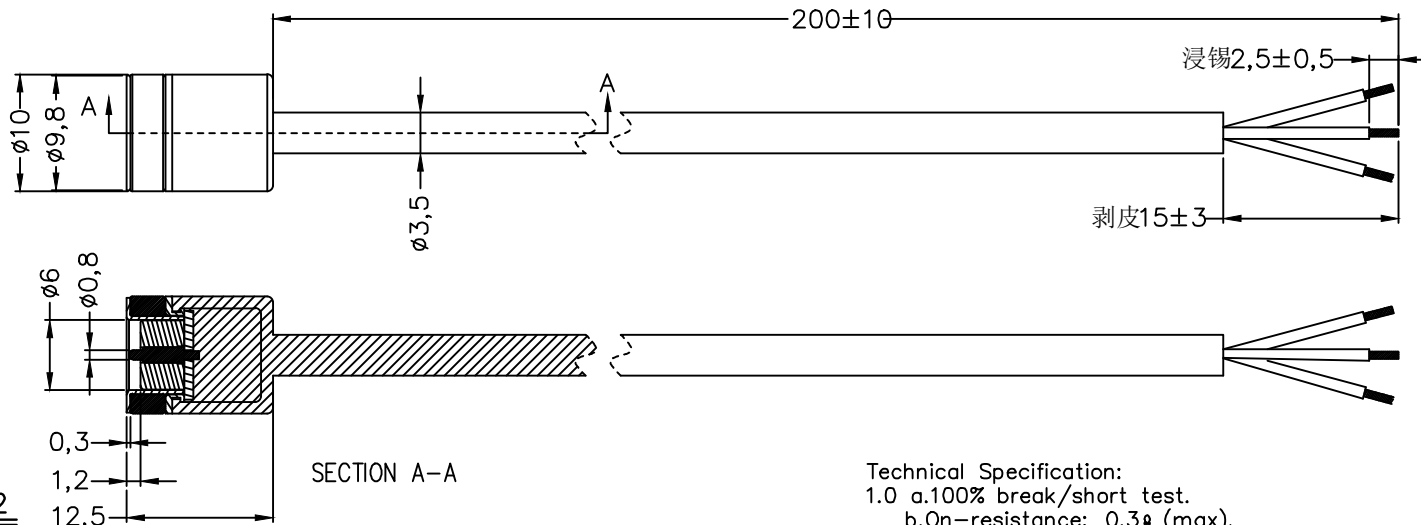
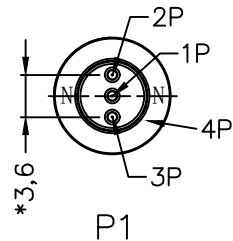

Wiring table

P1		P2	
1	White	CC	
2	red	VCC	
3			
4	black	GND	

Technical Specification:

- 1.0 a.100% break/short test.
b.On-resistance: 0.3 Ω (max).
c.Insulation resistance: 300V/DC 10M Ω (min).
- 2.0 Swing test: 200g lifting weight, ± 60 degrees 30 times/min, 2000 times conduction OK.
- 3.0 Rated voltage (PIN contact): 5Volts
- 4.0 Rated current (PIN contact): 3A maximum
- 5.0 Working elastic single PIN:
1).Press stroke 0.8mm (PIN contact): 50gfMax
- 6.0 Life test:
1)Press stroke 0.8mm, 10,000 times (Min)
- 7.0 The minimum magnetic suction force should be more than 220 grams
- 8.0 Operating temperature range: $-40\sim 85^{\circ}\text{C}$
- 9.0 is marked with "*" as a key dimension.
- 10.0 The product must conform to the latest RoHS CP65

9	electrode ring	H59	Ni1.25~3.0um+Pd 0.075um	1pcs	-
8	Press ring	H59	Nickel plated after 48 hours of salt spray	1pcs	-
7	magnet	N52	Nickel plated after 48 hours of salt spray	1pcs	-
6	pogopin	HBI59-1.5	Plunger Ni1.25~3.0um+Pd 0.075um Barrel Ni1.25~3.0um+Pd 0.025um	3pcs	-
5	PCB	FR-4	-	1pcs	-
4	Housing	PA9T gray	Fire rating: UL94V-0	1pcs	-
3	Outer mold	TPE 90A gray	Fire rating: UL94V-0	1pcs	-
2	Internal mold	LD-PE transparent	-	1pcs	-
1	Wire rod	TPE gray	Fire rating: UL94V-0	0.2m	OD: $\phi 3.5$
Item	Part Name	Material	Finish	Q'TY	Remarks

*UNLESS OTHERWISE STATED
ALL DIMENSIONS ARE IN
MILLIMETRES
LINEAR TOLERANCE:
X: ± 0.20 .X: ± 0.15 .XX: ± 0.10
X*: $\pm 2^{\circ}$.X*: $\pm 0.5^{\circ}$
Pomagtor
Website:www.pomagtor.net

POMAGTOR
PROFESSIONAL CUSTOMIZATION SINCE 2007
HIGH FREQUENCY POGO PIN MAGNETIC CONNECTOR

ITEM	Magnetic connector	REV	A2	DRAWN BY	CHECKED BY	APPROVED BY
S/N.	HY901.0301800020-01	SCALE	1	LZH		
RD.S/N.	RD90.LZH0220704-002	UNIT	mm			
VEIW ANGLE		DATE	2022/10/11			
		SHEET	1 of 1			