

NOTES:

- 1.0 PLATING:
- 1) Contact plating: brass Au5u"over 50--80u" Ni
 - 2) Spring: SUS
 - 3) Housing: TPE white
 - 4) Magnet: IN52
 - 5) Cable: TPE, DD3.5
 - 6) PCB: FR4
- 2.0 Rated voltage(Per Contact): 5 Volts
- 3.0 Rated Current(Per Contact): 3A maximum
- 4.0 Recommended Working Stroke&Force:
- 1) Stroke 0.8mm(Per Contact): 60gfMax
 - 5.0 Mechanical life:
 - 1) 0.8mm(Mechanical life): 10,000 Cycles Min
 - 6.0 Working Temperature Range: -30~85°

POMAGTOR
磁性连接—專業為您定制

深圳市泰科汉泽精密电子有限公司
Pomagtor Precision Electronics

模具编号		模仁编号		
-----		-----		
-----		-----		
-----		-----		
序号	变更描述	原因	设计者	日期
1	-----	-----	-----	-----
2	-----	-----	-----	-----
3	-----	-----	-----	-----

描述		料号		料号		料号		料号	
10mm-2PIN-圆形水杯-直出一公座		-----		-----		-----		-----	
规格编号		-----		-----		-----		-----	
未标注尺寸公差 +/-0.15		-----		-----		-----		-----	
未标注角度公差 +/-2°		-----		-----		-----		-----	
单位		mm		比例		1:1		-----	
审核/日期		-----		-----		-----		-----	

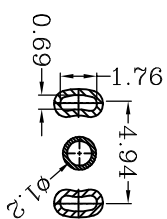
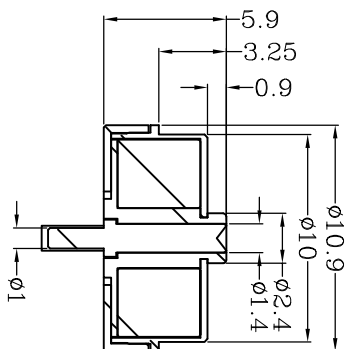
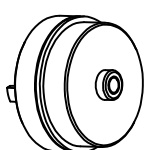
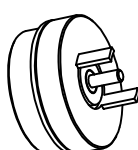
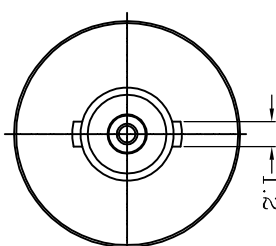
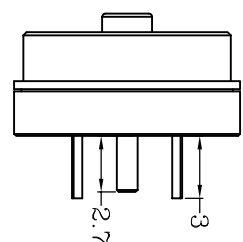
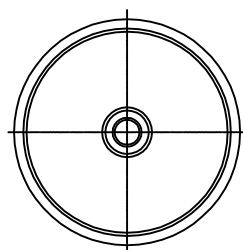

PCB LAYOUT
Layout Tolerance: ±0.05mm

- NOTES:
1.0 PLATING:
1) Contact plating: brass Au5u"over 50-80u" NI
2) Contact solder area plating: brassAu 5u" over 50-80u" NI
3) Housing: ICP while
4) Magnet: INS2
2.0 Rated voltage (Per Contact): 5 Volts
3.0 Rated Current (Per Contact): 3A maximum
4.0 Working Temperature Range: -30~85°

模具编号

POMMAGTOR
磁性连接—专业为您定制

深圳市泰科汉泽精密电子有限公司
Pomagtor Precision Electronics

序号	变更描述	原因	设计者	日期	描述	料号	图档编号	单位	版本
1	-----	-----	-----	-----	10mm-2PIN-圆形水杯-母座	-----	-----	mm	A1
2	-----	-----	-----	-----	未标注尺寸公差 +/- 0.15	-----	-----	mm	比例 1:1
3	-----	-----	-----	-----	未标注角度公差 +/- 2°	-----	-----	mm	2017.12.01

变更记录

1 2 3 4 5 6